

# BUILT-IN PART

INC 062

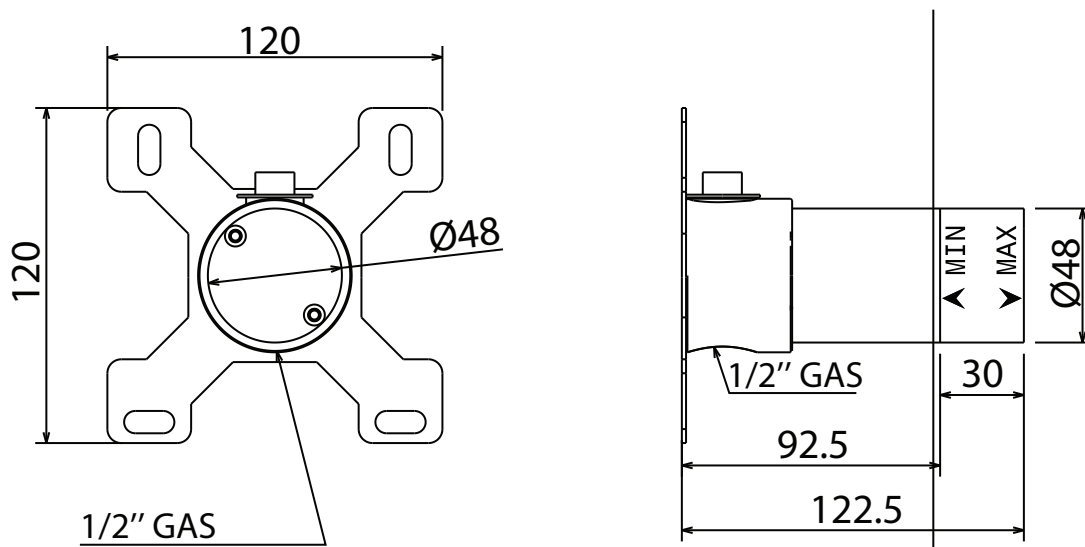

Built-in part  
Parte incasso